

FYL-3044YD1C

Features:

- General purpose leads
- RoHs complant.

Descriptions:

- Dice material: GaP
- Emitting Color: Yellow
- Device Outline: Standard 3mm diameter package..
- Lens Type: Yellow diffused

Radiation pattern.

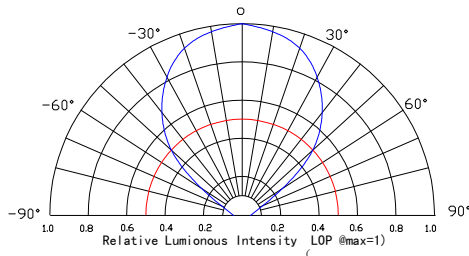

Package configuration

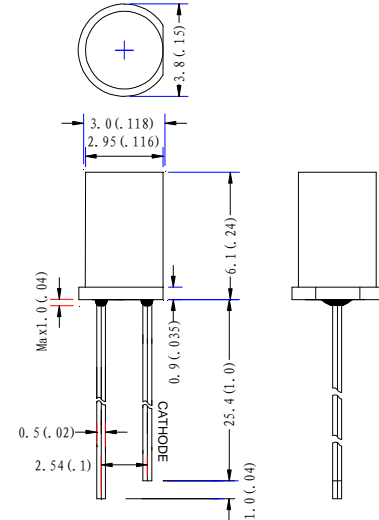

- ◆ All dimensions are millimeters (inches)
- ◆ Tolerance is $\pm 0.25\text{mm}(.010\text{'})$ unless otherwise noted.

Absolute maximum ratings($T_a=25^\circ\text{C}$)

Parameter	MAX.	Unit
Power Dissipation	50	mW
Peak Forward Current (1/10 Duty Cycle, 0.1ms Pulse Width)	100	mA
Continuous Forward Current	20	mA
Derating Linear From 50°C	0.4	$\text{mA}/^\circ\text{C}$
Reverse Voltage	5	V
Operating Temperature Range	-30°C to $+80^\circ\text{C}$	
Storage Temperature Range	-40°C to $+100^\circ\text{C}$	
Lead Soldering Temperature[4mm(.157") From Body]	260 $^\circ\text{C}$ for 5 Seconds	

Electrical and optical characteristics($T_a=25^\circ\text{C}$)

Parameter	Symbol	Min.	Typ.	Max.	Unit	Test Condition
Luminous Intensity	IV	-	30	-	mcd	IF=20mA
Viewing Angle	$2\theta_{1/2}$	90	100	110	Deg	
Peak Emission	λ_p	586	591	596	nm	
Dominant Wavelength	λ_d	583	588	593	nm	
Spectral Line Half-Width	$\Delta\lambda$	10	15	20	nm	
Forward Voltage	VF	1.6	2.0	2.4	V	VR=5V
Reverse Current	IR			50	μA	

Typical Electrical Characteristics Curves (25 °c Ambient Temperature Unless Otherwise Noted)

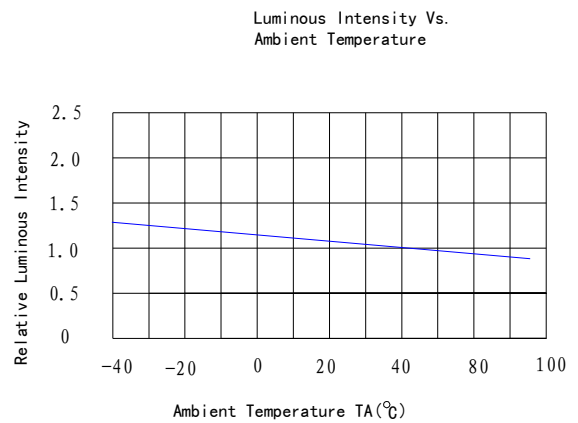
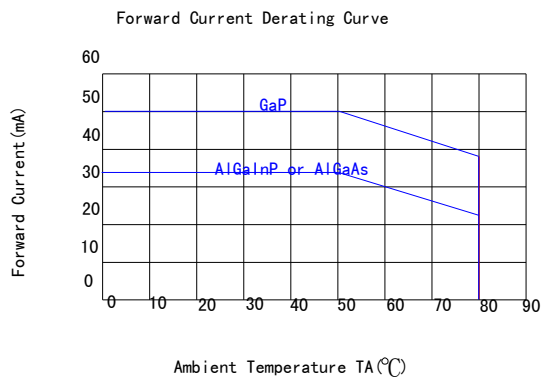
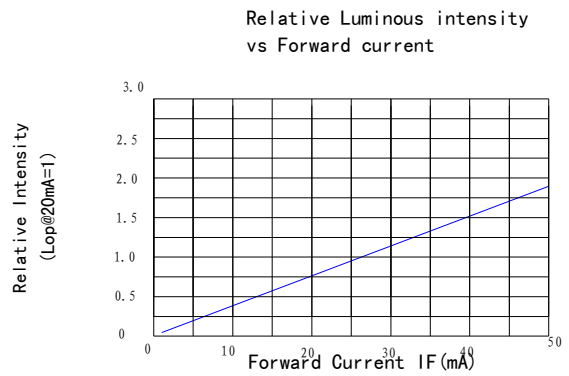
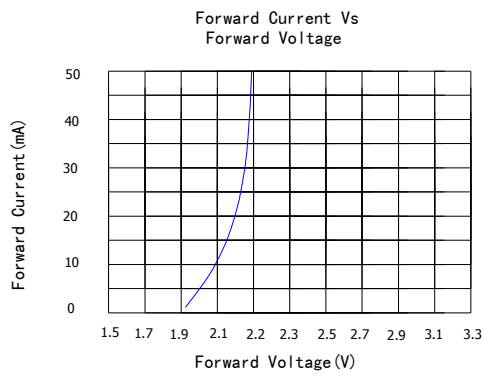
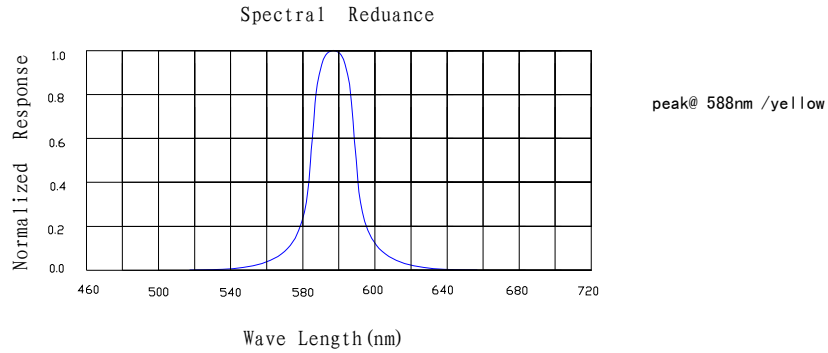

LAMP PACKING.

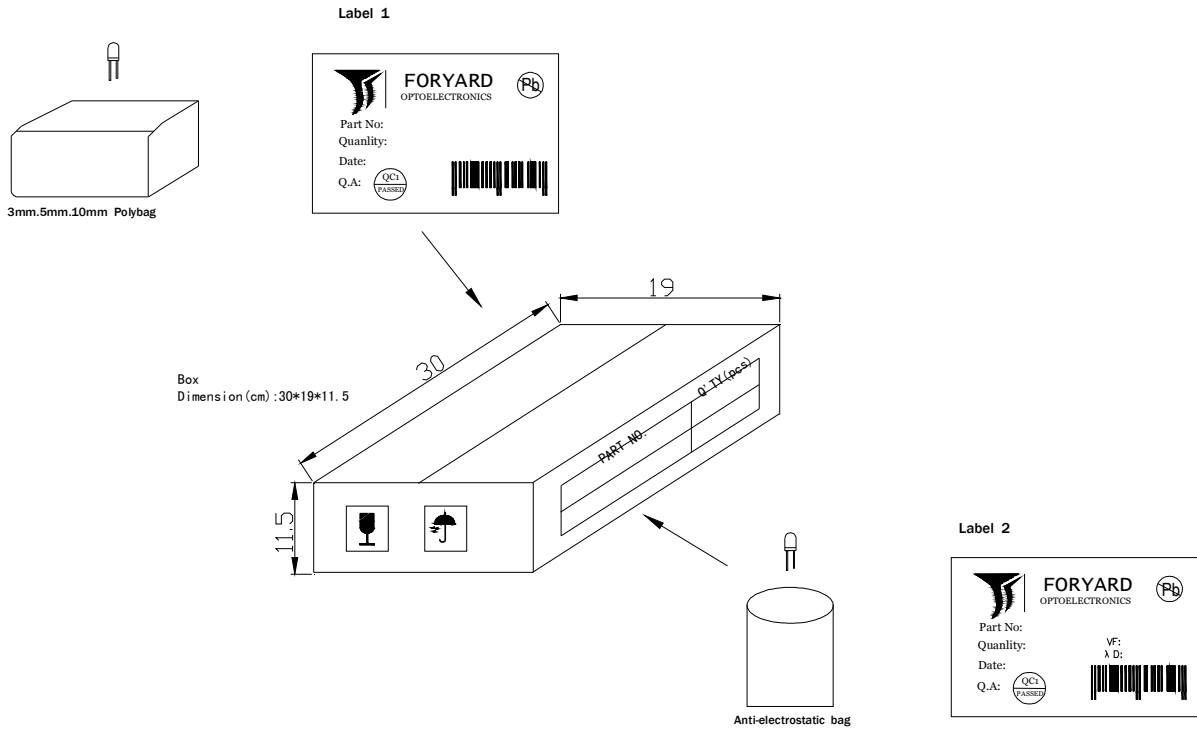

DEVICE	QTY/polybag(pcs)	Polybag/box A	Fig
5mm(T-1 3/4)	1000	8 bags	Label 1
3mm(T-1)	1000	10 bags	Label 1
10mm(T-1)	250	8 bags	Label 1
Blue/Green/White	500pcs	8 bags	Label 2

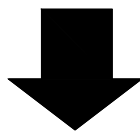

CARTON
Dimension(cm):39*32*38

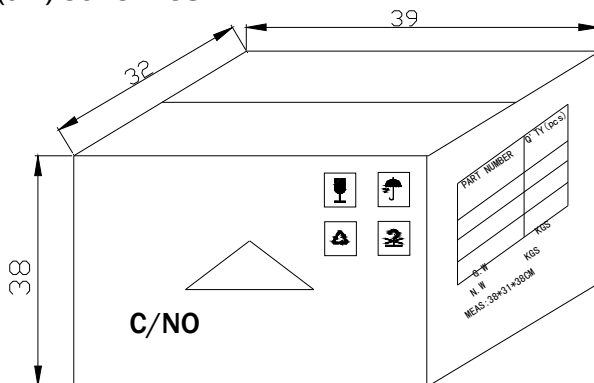

6 Boxes/Carton
 5mm:48,000pcs
 3mm:60,000pcs
 10mm:12,000pcs
 Blue/Pure Green/bluish Green
 /White:24,000pcs